



Installation Instructions

718143

2022-2025 TOYOTA TUNDRA
WITH 3.5L ENGINE

2- or 4-WHEEL DRIVE

145.7 IN., 157.7 IN., and 164.6 IN. WHEELBASE

See "Applications" tab on the product web page for specific applications.

| ITEM | PART NO. | DESCRIPTION | QTY. |
|------|-----------|-------------------------------|------|
| 1 | 86737M | RIGHT INLET PIPE | 1 |
| 2 | 86736M | LEFT INLET PIPE | 1 |
| 3 | 72468-598 | FLOWFX MUFFLER | 1 |
| 4 | 86738M | TAILPIPE ASSEMBLY | 1 |
| 5 | TB932M | EXTENSION PIPE | 2 |
| 6 | MC250BS | CLAMP, STAINLESS, 2-1/2" | 6 |
| 7 | HA572 | FRAME HANGER | 1 |
| 8 | HW204 | BOLT, 5/16-18 x 1" | 1 |
| 9 | HW102 | NUT, 5/16-18 | 1 |
| 10 | HW305 | FLAT WASHER, 5/16" | 1 |
| 11 | HW302 | FENDER WASHER, 5/16" x 1-1/4" | 1 |
| 12 | HW308 | LOCK WASHER, 5/16" | 1 |

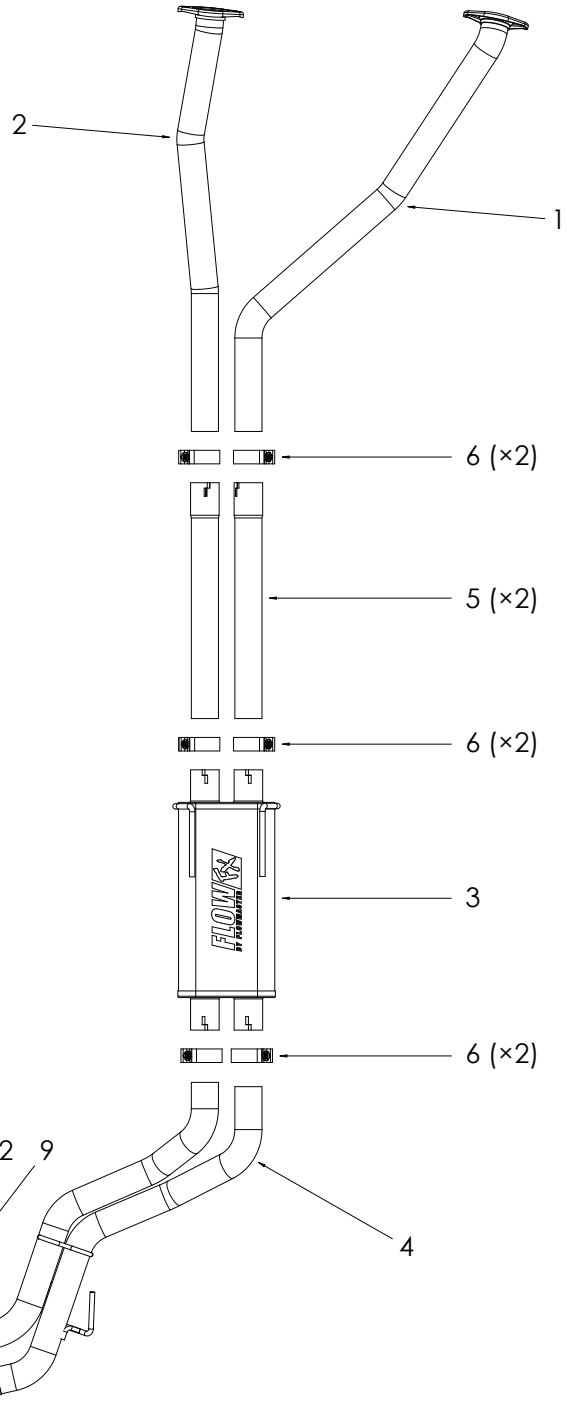

NOTES

- Installation requires moderate mechanical skill. If this job is beyond your abilities, seek the services of a qualified technician.
- If you do not understand any part of these instructions, please call Flowmaster Technical Support at (866) 464-6553 for assistance.
- Apply penetrating oil generously to clamps, fasteners, pipes, and hanger rods for ease of disassembly.

REVIEW THE INSTRUCTIONS & VERIFY THE KIT CONTENTS

Take a moment to read and understand these instructions before installing your Flowmaster FlowFX exhaust kit.



Use the parts drawing and list to verify your kit's contents. In the unlikely event that any parts are missing, please contact Flowmaster Technical Support for replacements.

REMOVE THE FACTORY EXHAUST SYSTEM

WARNINGS

- **AVOID BURNS!** Exhaust systems get extremely hot. Allow the vehicle to cool down fully before starting work.
- **AVOID SERIOUS INJURY OR DEATH BY CRUSHING!** Never work under a vehicle that is supported by jacks.
- **EXHAUST SYSTEM COMPONENTS ARE HEAVY!** Use jack stands to support them, both when removing the stock system, and when installing your new kit.

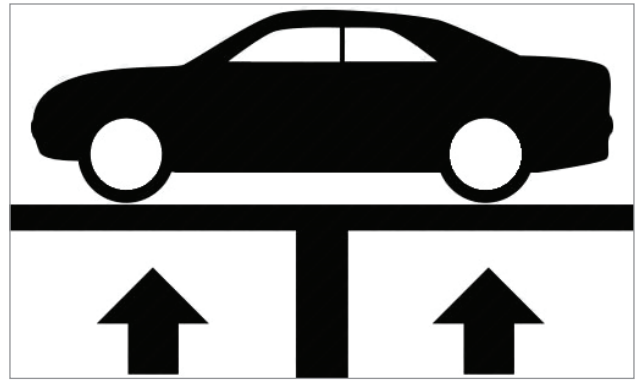

1. **Raise the vehicle** to working height on a lift. If you do not have a lift, securely support the vehicle on jack stands.

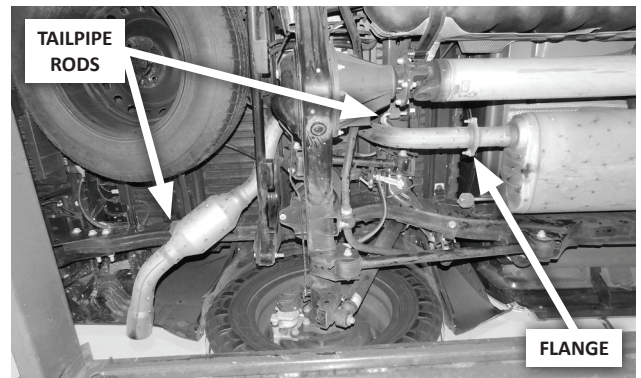

2. **Remove 2 nuts at the tailpipe flange.** Disengage tailpipe rods from rubber isolators (2 places).



3. **Lower the spare tire for clearance,** and remove the tailpipe from the vehicle.

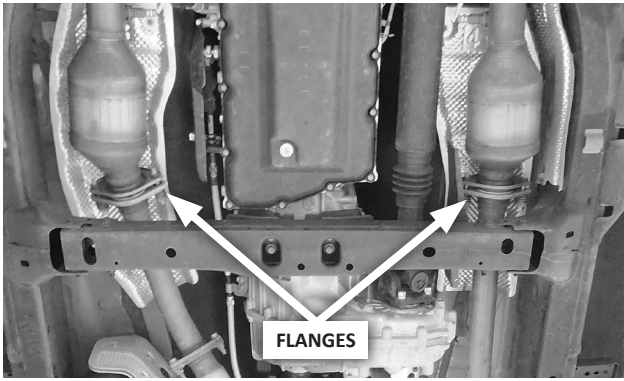

4. Remove and retain 4 screws and springs at the 2 catalytic converter flanges.



5. Disengage muffler rods from rubber isolators (3 places), and remove muffler and pipe assembly from vehicle. Remove and retain 2 flange gaskets. Retract the spare tire to its stowed position.

INSTALL YOUR FLOWMASTER EXHAUST SYSTEM



6. Before installing clamps in the following steps, remove their nuts, apply anti-seize compound to the bolt threads, and re-install the nuts.

NOTE: All pipe-to-pipe slip-fit connections must seat 3" deep. All pipe-to-muffler connections must seat 2" deep. Mark the male ends of each pipe in advance, to ensure proper insertion during assembly.



7. Attach left and right inlet pipes (2 and 1) to factory exhaust with the 2 stock gaskets, and 4 screws and springs, ensuring that both pipes are oriented properly.

| CAB | BED | WHEELBASE | EXTENSION PIPES |
|---------|--------|-----------|-----------------|
| Double | 8.1 ft | 164.6 in | Use as received |
| CrewMax | 6.5 ft | 157.7 in | Cut back 6-7/8" |
| Double | 6.5 ft | 145.7 in | Not used |
| CrewMax | 5.5 ft | | |

8. Determine if your truck requires the two extension pipes (5). If not, skip to Step 11.

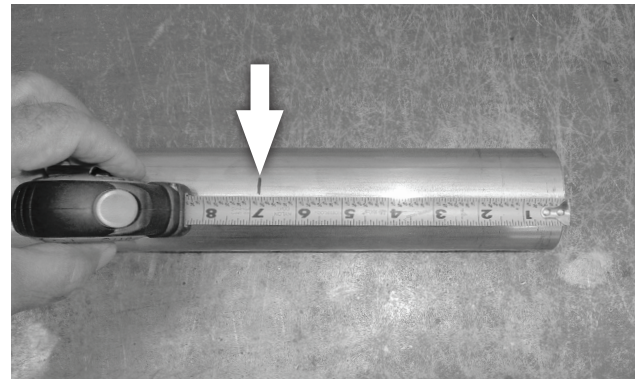

9. If applicable, cut 6-7/8" off the muffler-end of the extension pipes.
10. If applicable, slip a clamp (6) over each extension pipe, and install them on the inlet pipes. Verify 3" of insertion, and snug the clamps slightly (just enough to allow final adjustment later).

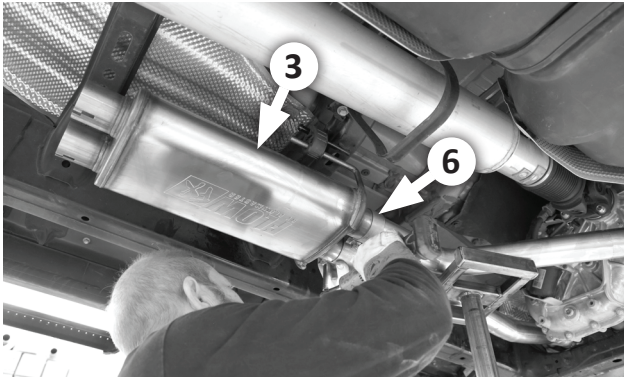

11. Slip two clamps (6) over the muffler's (3) inlets (the end with the hanger rods). Install the hanger rods in the rubber isolators, then install the muffler on the inlet pipes. Verify 2" of insertion, and snug the clamps slightly.



14. Adjust all components to give 1/2" to 3/4" clearance (about a finger's width) around them, and allowing for suspension travel and vibration. When you are satisfied with the system's clearance and fit, tighten all clamps.

15. Recommended: Tack weld (approx. 1") the slip-fit connections for added security, then paint each weld with a coat of high-temp spray paint to protect against corrosion.

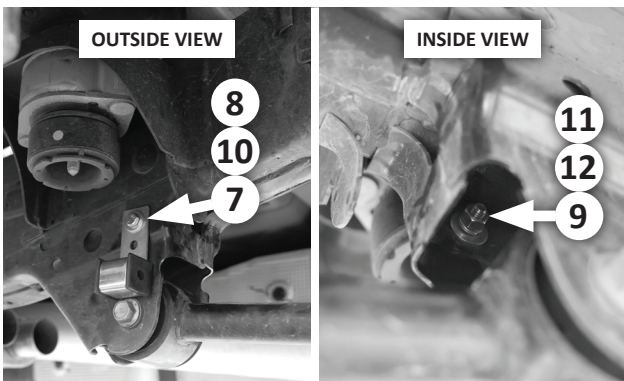

12. Install frame hanger (7) at the rearmost hole in the driver side lower control arm mount, using **bolt (8)** and **flat washer (10)** (against the hanger), and **fender washer (11)**, **lock washer (12)** and **nut (9)** inside the frame. Snug the fasteners slightly (to allow tailpipe installation, and final adjustment, later).



Congratulations, the installation of your Flowmaster FlowFX performance exhaust system is complete!

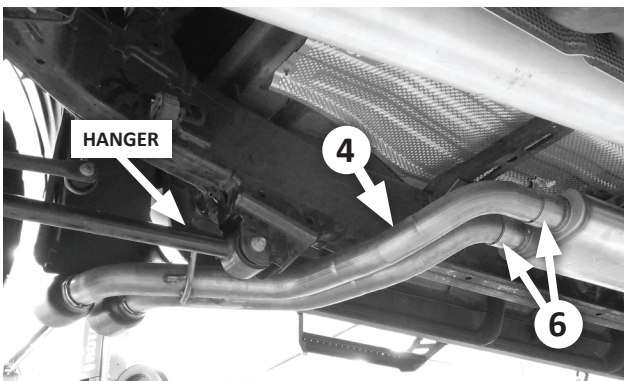

13. Slip clamps (6) over the muffler's outlets. Move the **tailpipe assembly (4)** into place, insert its hanger rod into the frame hanger, and insert the pipes into the muffler. Verify 2" of insertion, and snug the clamps slightly.

KEEP THESE INSTRUCTIONS FOR FUTURE REFERENCE

Flowmaster maintains a highly-trained technical service department to answer your technical questions, provide additional product information and offer various recommendations.



FLOWMASTER TECHNICAL SUPPORT: (866) 464-6553